

YOGA

YOGA

AG







Y&G

YOGA

AG

L'INSIEME DELLE TECNICHE CHE CONSENTONO IL CONGIUNGIMENTO DI CORPO, MENTE E ANIMA

per elevarsi al divino. La tecnica costruttiva del giunto in pressofusione di alluminio che consente il congiungimento tra elementi strutturali di servizio e superfici. Un "dettaglio" che caratterizza una raffinata e inusuale "cucitura" e crea una scrivania di forte personalità per tutte le necessità dell'ufficio di grande rappresentanza. Un'attenzione particolare ai materiali, alta riciclabilità degli stessi e rispetto dell'ambiente.

All the techniques which enable the union of body, mind and soul to rise the divine. The building technique of aluminium die-cast joint enabling the union between service structural elements and surfaces. A sort of "detail" that characterizes a refined and unusual "stitching" and creates a desktop with a strong personality for every kind of needs for a highly representative office. A particular attention to materials, high recycling ability of the same ones and environmental protection.

L'ensemble des techniques qui permettent la conjonction du corps, de l'esprit et de l'âme pour s'élever au divin. La technique de fabrication du joint en aluminium moulé sous pression qui permet la conjonction des éléments structurels de service et des surfaces. Un « détail » qui caractérise une « couture » raffinée et inhabituelle et qui crée un meuble de bureau avec une forte personnalité pour toutes les exigences d'un bureau de grande représentation. Une attention particulière accordée aux matériaux, à leur réutilisation et au respect de l'environnement.





UNA ZONA UFFICIO IMMERSA NELLO SPAZIO FRA ARMONIA E LUCE.

Un progetto caratterizzato dal grande contenitore portante e di servizio che crea un'isola di dimensioni extralarge dal forte sviluppo orizzontale: un paesaggio del confort in cui superfici e volumi compongono geometrie di grande originalità, attrezzate con ante scorrevoli e grandi vani a giorno.

An office area plunged in the space between harmony and light. A project characterized by a large bearing and service container, which creates a kind of extra-large island with a strong horizontal development: A comfort-oriented landscape in which surfaces and volumes make up extremely original layouts, equipped with sliding doors and large open compartments.

Une zone bureau insérée dans l'espace entre harmonie et lumière. Un projet caractérisé par le grand meuble portant et de service qui crée un îlot de dimensions extra larges ayant un développement horizontal prononcé : un paysage de confort où les surfaces et les volumes composent des géométries vraiment originales, équipées de portes coulissantes et de grands compartiments ouverts.









YOGA, UNA NUOVA DIMENSIONE DELLA CONTEMPORANEITÀ:

progetto di interiors definiti da forme essenziali e materiali ricercati. Ricerca di purezza e tattilità. Le nuove superfici in vetro no-print conferiscono una piacevole sensazione al tatto ed eliminano l'effetto impronta sui piani e sulle ante ad apertura push&pull.

Yoga, a new dimension of contemporaneity: An interiors project defined by essential shapes and elegant materials. Pursuit of purity and tactility. The new no-print glass surfaces give a pleasant feeling by touch and eliminate the imprint effect on push&pull surfaces and doors.

Yoga, une nouvelle dimension du contemporain : des conceptions d'intérieurs définies par des formes essentielles et des matériaux recyclés. Recherche de pureté et de tactilité. Les nouvelles surfaces en verre no-print confèrent une agréable sensation au toucher et éliminent les empreintes sur les plans et les portes à ouverture push&pull.







UNA PROPOSTA DALL'IMMAGINE HIGH-TECH:

volumi primari che definiscono una nuova geometria del contenere. I mobili pensili, che permettono un'infinita componibilità grazie agli elementi a giorno, ad anta e alle mensole con supporto a scomparsa.

A proposal coming from high-tech images: primary volumes, which define a new encompassing geometry.
Wall units, which enable an endless unit furniture setting, thanks to the open elements, door units and shelves with concealed support.

Une proposition suggérant une image hautement technologique : des volumes primaires qui définissent une nouvelle géométrie du meuble.
Les meubles suspendus permettant une modularité infinie grâce aux éléments ouverts ou avec porte et aux étagères avec support escamotable.





UNA COLLEZIONE IN CUI L'ORIGINALITÀ DEL DESIGN È AFFIANCATA DALLA VOLONTÀ

di formulare proposte in cui si incontrano essenze e metallo in una sintesi compositiva evoluta. La naturalezza del legno e la tecnicità del metallo si intersecano creando un layout compositivo naturale e di grande pregio.

A collection where the design novelty is backed by the will to formulate proposals in which fragrances and metal meet in an evolved constituent synthesis. The naturalness of wood and the technicity of metal criss-cross by creating a natural composition and high quality layout.

Une collection où l'originalité du design va de pair avec la volonté de formuler des propositions où les essences et le métal se rencontrent dans une synthèse de composition évoluée. La naturalité du bois et la technicité du métal s'entrecroisent en créant une composition naturelle et de haute qualité.





GRANDE ATTENZIONE PER I PARTICOLARI E PER GLI ACCESSORI

che semplificano ed agevolano lo svolgimento del lavoro. Tecnologia e funzionalità si integrano alle connessioni dei cablaggi e collegano il posto lavoro al mondo globale con una corretta gestione dei cavi.

Great attention for details and accessories that simplify and facilitate work development. Technology and practicality integrate with the wirings connections and connect the workplace to the global world with a correct management of cables.

Une attention spéciale aux détails et aux accessoires qui simplifient et facilitent l'exécution du travail. La technologie et la fonctionnalité se marient aux connexions des câblages et connectent le poste de travail au monde global suivant une gestion cohérente des câbles.





LAVORO SINGOLO O DI EQUIPE: SPAZI PER DECIDERE,

Lavoro singolo o di equipe: spazi per decidere, per aggregarsi, per consultarsi, per risolvere le necessità. Yoga ricerca armonia e risolve la componibilità dalla scrivania al grande tavolo riunione caratterizzato dal supporto canalizzato. Materiali e colori consentono di personalizzare il proprio spazio e creare l'equilibrio perfetto per ogni situazione.

Individual work or team work: spaces for decisions, aggregation, consulting and to solve needs. Yoga looks for harmony and solves the unite furniture setting from the desk to the large conference table characterized by the piped support. Materials and colours enable to customize one's own space and to create a perfect balance for every situation.

Travail individuel ou en équipe : des espaces pour décider, se rencontrer, se consulter, résoudre toute exigences. Yoga recherche l'harmonie et asservit la modularité du bureau à la grande table de réunion caractérisée par un support canalisé. Des matériaux et des couleurs permettant de personnaliser son espace personnel et de créer un équilibre parfait pour chaque situation.





POSTAZIONE "OPERATIVA" MULTIFUNZIONALE E NUCLEO CONVIVIALE

caratterizzato dal grande piano di lavoro che trova la negli elementi particolari , ante, cornici in alluminio, elementi verniciati, vetri extralight il proprio dettaglio caratterizzante. Gli elementi funzionali come i piedini regolabili, le maniglie, i passacavi creano un equilibrio nella massima coerenza stilistica.

Multifunctional "operating" position and convivial core characterized by a large worktop, which finds its own characterizing detail in the particular elements, doors, aluminium frames, varnished elements, extra-light glasses. The functional elements such as the adjustable feet, handles, fairleads create a balance in the utmost stylistic coherence.

Poste « opérationnel » multifonction et noyau convivial caractérisé par un grand plan de travail qui trouve dans les détails, les portes, les cadres en aluminium, les éléments peints, les vitres extra light, l'élément caractéristique de chacun. Les éléments fonctionnels comme les pieds réglables, les poignées, les passe-câbles créent un équilibre dans le maximum de cohérence stylistique.









LEGGEREZZA, ELEGANZA E MODULARITÀ,

un progetto ispirato al fascino della modernità e alla essenzialità della funzione. Lo scaffale libreria è declinato in una infinità di finiture e colori. La struttura in alluminio verniciato e le mensole in cristallo o nobilitato colorato si adattano ad ogni ambiente tra infiniti giochi di riflessi.

Lightness, elegance and modularity, a project inspired to the appeal of modernity and the essentiality of the function. The bookcase shelf is presented in an endless number of finishes and colours. The varnished aluminium structure and the crystal or faced wood shelves can suit every setting among an endless number of games and reflexes.

Légèreté, élégance et modularité, un projet s'inspirant du charme de la modernité et de la fonctionnalité essentielle. Le meuble bibliothèque est décliné dans une gamme infinie de couleurs et de finitions. La structure en aluminium peint et les étagères en cristal ou avec revêtement en bois coloré s'adaptent à tout intérieur entre des jeux de reflets infinis.







PIANI AMPI, DUPLICABILI ALL'INFINITO, IL COLORE DEL LEGNO,

l'attenzione al design e l'abbinamento dei materiali per guardare oltre l'orizzonte conosciuto e trovare nuove idee e soluzioni sempre più evolute. Dal tavolo singolo al composto per creare spazi riunione dalle dimensioni infinite.

Wide surfaces, endlessly applicable, the colour of wood, the attention to design and the combination of materials to look beyond the known horizon and find new ideas and more and more evolved solutions. From single to composite tables, to create conference areas of endless dimensions.

De vastes plans, pouvant être dupliqués à l'infini, la couleur du bois, l'attention au design et à l'assortiment des matériaux pour regarder au-delà de l'horizon connu et trouver de nouvelles idées et des solutions de plus en plus à l'avant-garde. De la table individuelle à la composition pour créer des espaces réunion aux dimensions infinies.









UN'INTERPRETAZIONE
DEL CLASSICO.
UNO SPAZIO CON LA
PROPRIA FUNZIONE,
L'AGGREGAZIONE.

L'essenzialità delle forme crea una naturale eleganza che predilige raffinati contrasti cromatici, nel valore della semplicità. L'accostamento dei piani di spessore minimo, la gamma di finiture e la leggerezza della struttura permette di creare infinite soluzioni per ogni tipo di gusto estetico.

An interpretation of the classical style. A space with its own function, the aggregation. The essentiality of shapes creates a natural elegance that prefers refined chromatic contrasts, in the value of simplicity. The matching of minimum thickness surfaces, the range of finishes and the lightness of the structure enable you to create endless solutions for every kind of taste.

Une interprétation du classique. Un espace avec sa propre fonction, l'agrégation. Les formes essentielles créent une élégance naturelle qui prime les contrastes chromatiques raffinés, dans la valeur de la simplicité. L'assemblage des plans d'une épaisseur minimale, la gamme de finitions et la légèreté de la structure permet de créer des solutions infinies pour répondre à tout type de goût esthétique.

GEOMETRIE PURE E DETTAGLI STILISTICI IN SOTTILE CONTINUITÀ CON IL PASSATO E LA TRADIZIONE.

Un'estetica dei contrari apparenti, di materia e trasparenza, in piena armonia. Più che un sistema Yoga è una partitura aperta, un catalogo di possibilità con cui progettare regole ed eccezioni. Ordine senza monotonia: materiali, finiture e componenti sono variazioni tematiche con cui comporre nello spazio il ritmo delle nostre giornate.

Pure geometries and stylistic details in a subtle continuity with the past and the tradition. A kind of appearance of apparent opposites, of matter and transparency, in full harmony. Rather than being a system, Yoga can be defined as an open score, a catalogue of opportunities by which it is possible to design rules and exceptions. Order without monotony: Materials, finishes and components are theme variations with which to make up the rhythm of our days in space.

Des géométries pures et des détails stylistiques dans une continuité subtile avec le passé et la tradition. Une esthétique des contraires apparents, de la matière et de la transparence, en pleine harmonie. Plus qu'un système Yoga est une partition ouverte, un catalogue de possibilités avec lequel projeter des règles et des exceptions. De l'ordre sans monotonie: matériaux, finitions et composants sont des variations thématiques avec lesquelles composer dans l'espace le rythme de nos journées.







CONTENITORI MA ANCHE SEMPLICI RIPIANI APERTI E MODULI CHIUSI,

Contenitori ma anche semplici ripiani aperti e moduli chiusi, mensole e basi, consolle a muro, ma anche semplici tavoli circolari. Elementi per mostrare e per nascondere. Infinite declinazioni per sfruttare al meglio lo spazio grazie ad una completa gamma di composizioni che moltiplicano l'ecletticità del sistema.

Containers as well as simple open shelves and closed modules, shelves and bases, wall panels, as well as simple round tables. Elements to show and to hide. Endless declinations to exploit the space to the fullest, thanks to a complete range of compositions, which multiply the eclectic quality of the system.

Des meubles de rangement mais aussi de simples tablettes ouvertes et des modules fermés, des étagères et des bases, des consoles murales, mais aussi de simples tables circulaires. Des éléments pour montrer et pour cacher. Des possibilités infinies pour exploiter de la meilleure façon l'espace grâce à une gamme complète de compositions qui multiplient l'éclectisme du système.





FINITURE E SOLUZIONI TECNICHE IN PRIMO PIANO PER DARE IL GIUSTO RISALTO

al progetto globale della collezione. Dettagli di un sistema funzionale per risolvere la connessione del proprio posto lavoro con il mondo. Funzionalità e razionalità; tutti i componenti sono predisposti per alloggiare cablaggi e cavi di alimentazione. Gonne frontali, porta-cpu, gambe intermedia canalizzata per ogni esigenza particolare.

Finishes and technical solutions in close-up to accentuate the global project of the collection. Details of a functional system to solve the connection of one's workstation with the world. Functionality and rationality, all the components are prearranged to lodge wirings and feeder cables. Modesty panels, CPU holder, ducted intermediate legs for every special need.

Des définitions et des solutions techniques au premier plan pour faire ressortir de la meilleure façon possible le projet global de la collection. Les détails d'un système fonctionnel pour connecter son poste de travail au monde entier. Fonctionnalité et rationalité, tous les composants sont prévus pour loger des câblages et des câbles d'alimentation. Panneaux frontaux, porte-cpu, jambe intermédiaire canalisée pour toute exigence particulière.





IMPIALLACCIATI
WOOD VENEER
PLAQUÉS



i1NC Noce chiaro - Light Walnut
Noyer Clair



i1NS Noce scuro - Dark Walnut
Noyer Sombre

ESSENZE MELAMMINICHE
MELAMINE TYPES
ESSENCES MELAMINE



N3BD Bianco Dance - White Dance
Blanc Dance



N2WE Wengè - Wenge
Wenge



N1NN Noce Naturale - Natural Walnut
Noyer Naturel



N3CB Ciliegio Blues - Cherry Blues
Cerise Blues



N3LG Larice Glam - Larch Glam
Mélèze Glam



N3NS Noce Soul - Walnut Soul
Noyer Soul



N3RF Rovere Funk - Durmast Funk
Chêne Funk



N3RT Rovere Twist - Durmast Twist
Chêne Twist

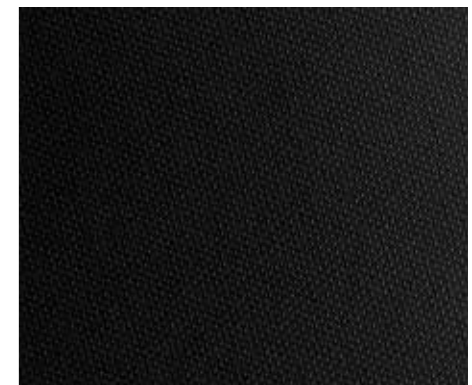

N3NJ Nero Jazz - Black Jazz
Noir Jazz

LACCATI OPACHI
 MATT LACQUERED
 LAQUÉES MATES



L_BD Bianco Dance - White Dance
 Blanc Dance



L_GY Grigio Yoga - Grey Yoga
 Gris Yoga

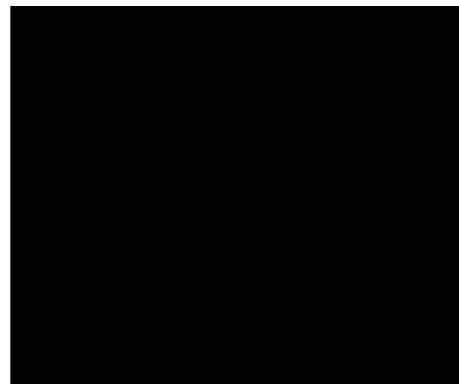

L_NY Nero Yoga - Black Yoga
 Noir Yoga

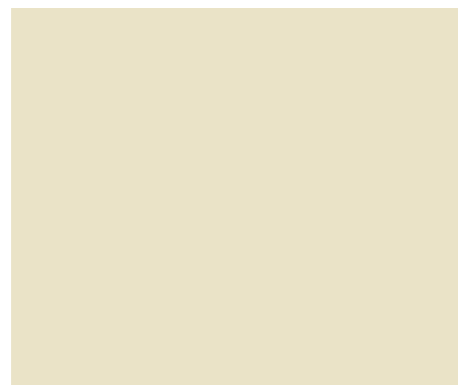

L_CR Cirpia Rosata - Rosy Face Powder
 Poudre Rose



L_SD Sabbia Desertica - Desert Sand
 Sable Du Désert



L_TS Tortora Selvatica - Wild Dove
 Tourterelle Sauvage



L_MC Melanzana Cruda - Raw Aubergine
 Aubergine Crue



L_RC Rosso Cardinale - Cardinal Red
 Rouge Cardinal



L_CL Cioccolato al latte - Milk Chocolate
 Chocolat au Lait



L_GS Grigio Scuro - Dark Grey
 Gris Sombre



L_RL Ral - Ral - Ral

VETRI
 GLASSES
 VERRES

LACCATI
 NO-PRINT
 NO-PRINT
 LACQUERED
 LAQUEES
 NO-PRINT



E3BD Bianco Dance - White Dance
 Blanc Dance



E1BD Bianco Dance - White Dance
 Blanc Dance



E1EC Extrachiaro - Extra light
 Extra clair



E3GY Grigio Yoga - Grey Yoga
 Gris Yoga



E1GY Grigio Yoga - Grey Yoga
 Gris Yoga



E3VS Satinato NO-PRINT
 NO-PRINT Satinated - Satiné NO-PRINT



E3NY Nero Yoga - Black Yoga
 Noir Yoga



E1NY Nero Yoga - Black Yoga
 Noir Yoga



V1GE Grigio Europeo - European Grey
 Gris Européen

LACCATI
 LACQUERED
 LAQUEES

TRASPARENTI
 CLEAR
 TRANSPARENTES



E3RL Ral - Ral - Ral



E1RL Ral - Ral - Ral

GAMBE - GIUNTI - TRAVI
 LEGS - JOINTS - BEAMS
 PIÈTEMENTS - LIAISON - POUTRE



A1BD/A2BD Bianco Dance - White Dance
 Blanc Dance



A1GY/A2GY Grigio Yoga - Grey Yoga
 Gris Yoga



A1NY/A2NY Nero Yoga - Black Yoga
 Noir Yoga



A1CF Cromo Funky - Chrome Funky
 Chrome Funky



A2RL Ral - Ral - Ral

MANIGLIE
 HANDLES
 POIGNÉES

320mm

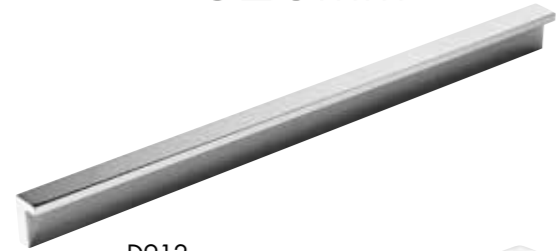

D912

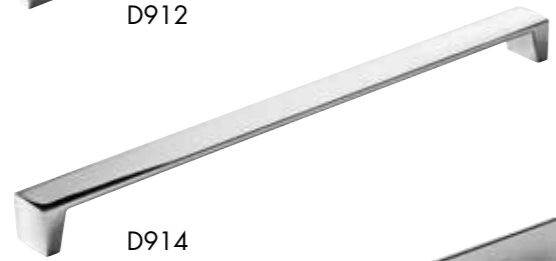

D914

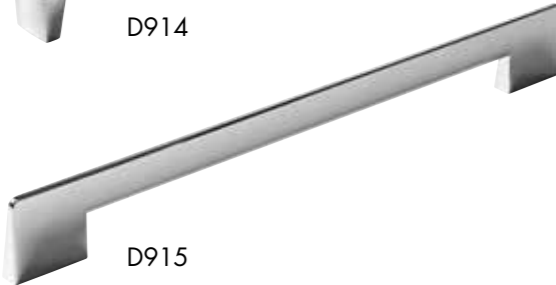

D915

160mm



D902



D904

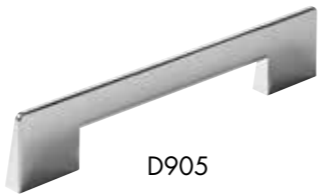

D905



ABBINAMENTI CONSIGLIATI GAMBA - GIUNTO

PER SCRIVANIE E TAVOLI CON PIANI ESSENZA, IMPIALLACCIATI, LACCATI ANTIGRAFFIO, VETRO LACCATO E VETRO NO PRINT

SUGGESTED COMBINATIONS LEG - JOINT

FOR DESKS AND TABLES WITH WORKTOPS IN MFC TYPES, VENEER, SCRATCH RESISTANT LACQUERED, LACQUERED GLASS AND NO-PRINT GLASS

ASSORTIMENTS RECOMMANDÉS PIÈTEMENT - LIAISON

POUR BUREAUX ET TABLES AVEC PLANS EN MÉLAMINÉ, PLAQUÉS, LAQUÉS ANTI-RAYURE, VETRE LAQUÉ ET VETRE NO-PRINT



A1BD, A1BD

A1GY, A1GY

A1NY, A1NY

A1CF, A1CF

A2RL, A2RL



A1BD, A1CF

A1GY, A1CF

A1NY, A1CF

A2RL, A1CF



A1CF, A1BD

A1CF, A1GY

A1CF, A1NY

A1CF, A2RL

N.B.: IN QUESTI ABBINAMENTI PER I PIANI COPRENTI, LA TRAVE È NELLA FINITURA A1GY GRIGIO YOGA ED IL PIEDINO È SEMPRE CROMATO
NOTE: FOR THESE COMBINATIONS FOR BLIND WORKTOPS, THE BEAMS ARE ALWAYS IN FINISH A2GY YOGA GREY AND THE FEET ARE ALWAYS CHROME FINISH

ATTENTION: AVEC CES ASSORTIMENTS SI LES PLANS DE TRAVAIS NE SONT PAS TRASPARENTS, LA POUTRE EN FINITION A2GY GRIS YOGA ET LE PIED EST TOUJOURS CHROMÉ

ABBINAMENTI CONSIGLIATI GAMBA - GIUNTO - TRAVE

PER SCRIVANIE E TAVOLI CON PIANIVETRO TRASPARENTE

SUGGESTED COMBINATIONS LEG-JOINT-BEAM

FOR DESKS AND MEETING TABLES WITH WORKTOPS IN TRANSPARENT GLASS

ASSORTIMENTS RECOMMANDÉS PIÈTEMENT-LIAISON-POUTRE

POUR BUREAUX ET TABLES AVEC PLANS EN VERRE TRASPARENT



A2BD, A2BD, A2BD

A2GY, A2GY, A2GY

A2NY, A2NY, A2NY

A1CF, A1CF, A1CF

A2RL, A2RL, A2RL

COMPONI YOGA:
CREATE YOUR YOGA:
FAITES VOS YOGA:

1 - SCEGLI LA GAMBA
CHOOSE LEG - CHOISIR PIÉTEMENT



2 - SCEGLI IL GIUNTO
CHOOSE JOINT - CHOISIR LIAISON



3 - SCEGLI LA TRAVE
CHOOSE BEAMS - CHOISIR POUTRE



4 - SCEGLI IL PIANO
CHOOSE WORKTOP - CHOISIR PLANS

IMPIALLACCIATI - WOOD VENEER - PLAQUÉS



ESSENZE - TYPES - ESSENCES



LACCATI - LACQUERED - LAQUÉES



VETRI LACCATI - LACQUERED GLASSES - VERRES LAQUÉES



VETRI LACCATI NO-PRINT - NO-PRINT LACQUERED GLASSES - VERRES LAQUÉES NO-PRINT

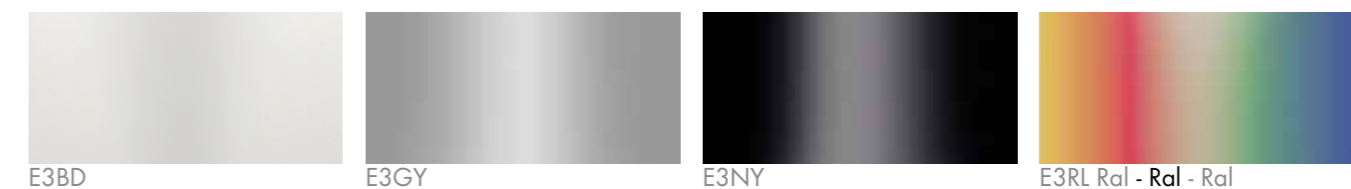

VETRI TRASPARENTI - CLEAR GLASSES - VERRES



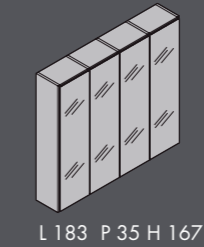
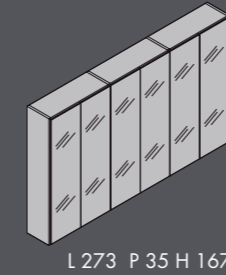
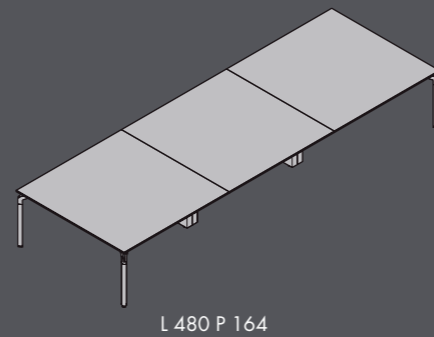
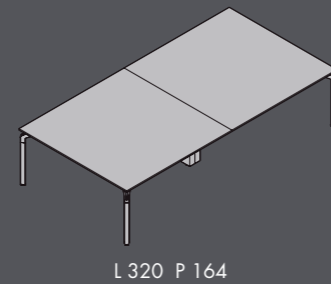
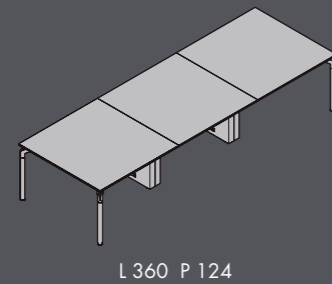
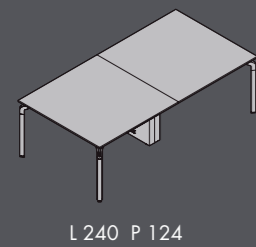
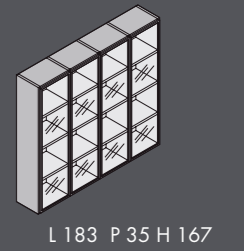
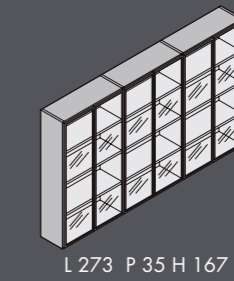
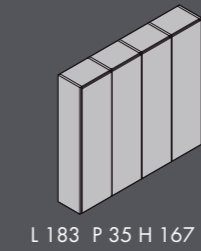
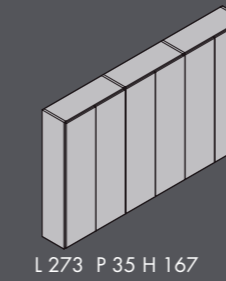
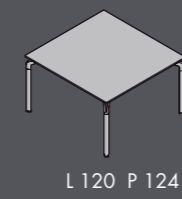
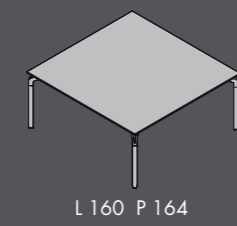
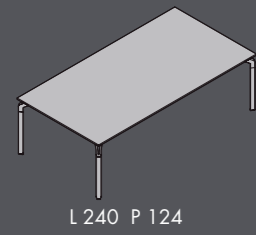
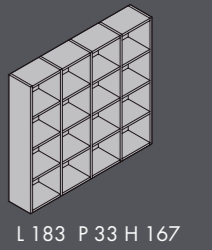
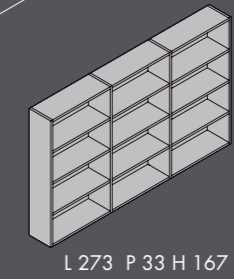
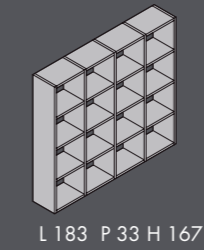
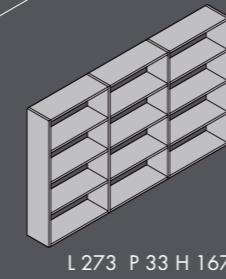
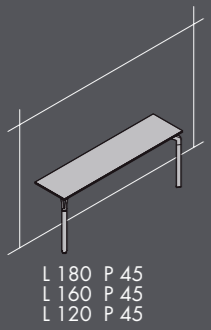
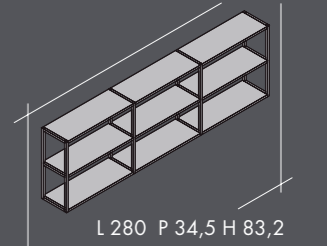
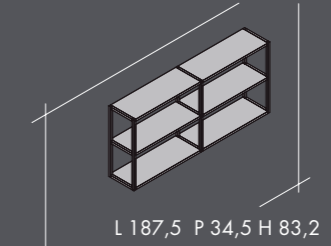
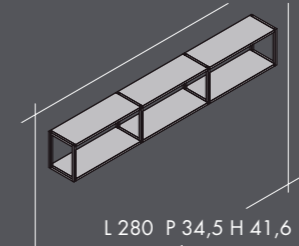
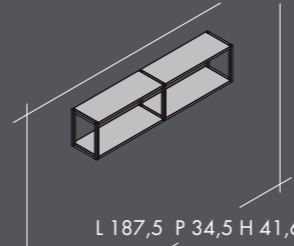
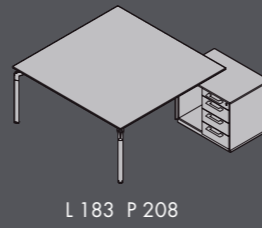
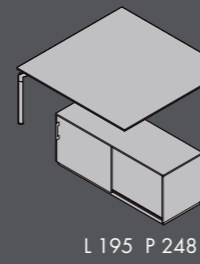
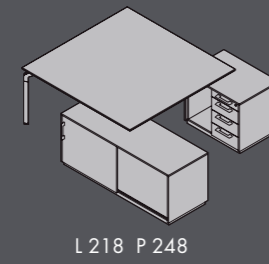
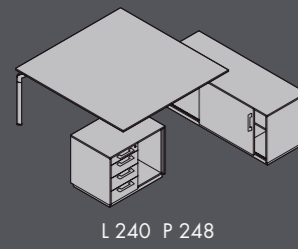
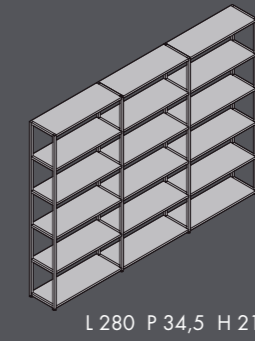
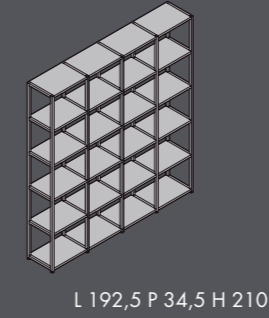
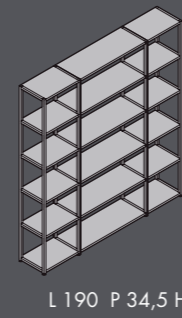
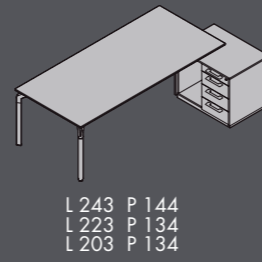
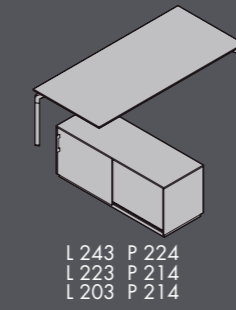
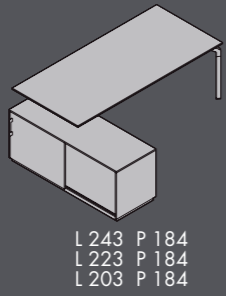
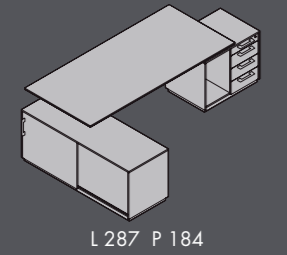
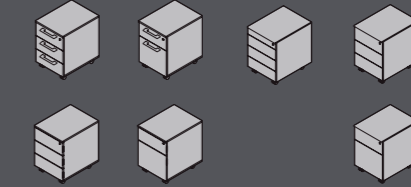
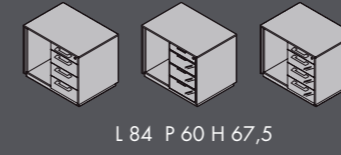
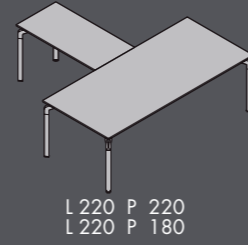
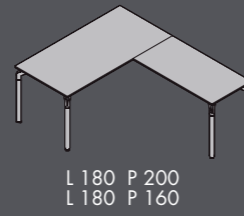
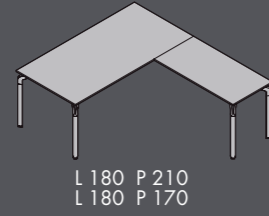
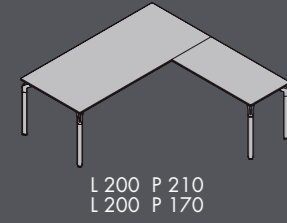
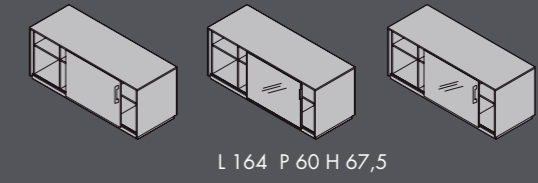
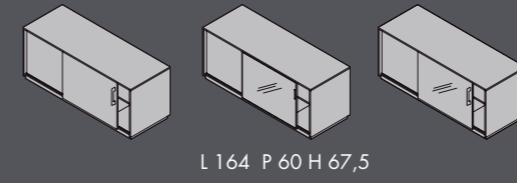
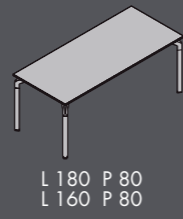
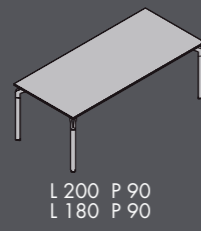
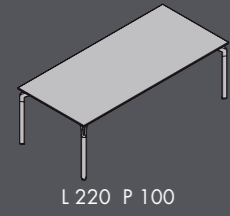

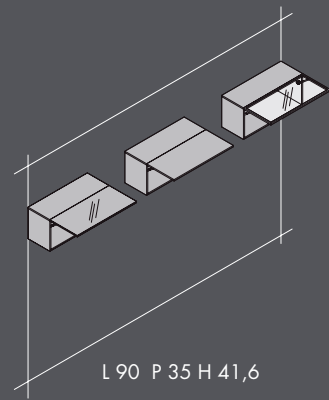

L 90 P 35 H 41,6

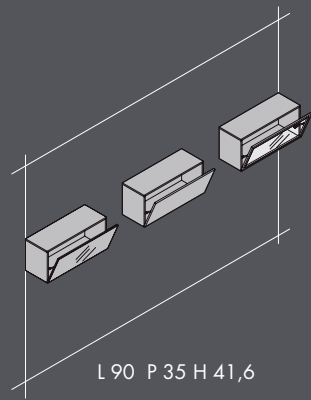

L 90 P 35 H 41,6

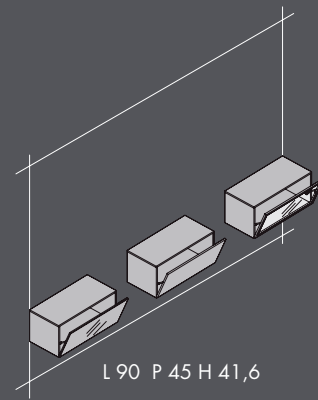

L 90 P 45 H 41,6

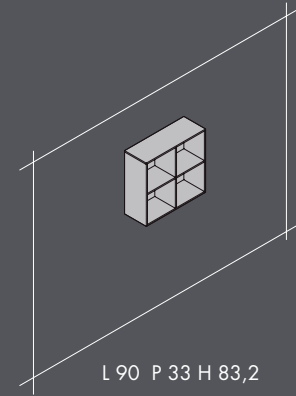

L 90 P 33 H 83,2

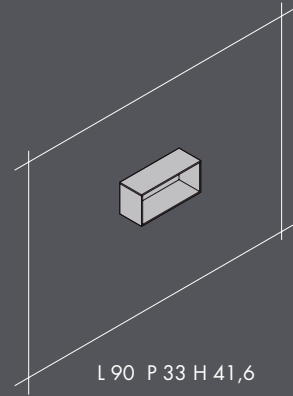

L 90 P 33 H 41,6

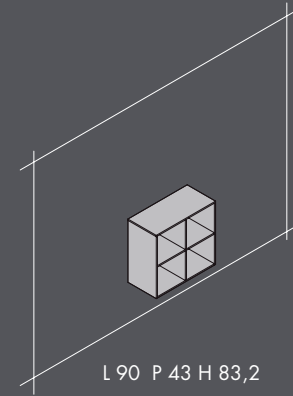

L 90 P 43 H 83,2

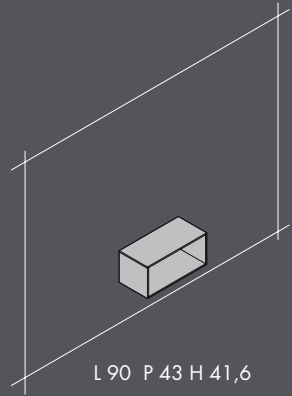

L 90 P 43 H 41,6

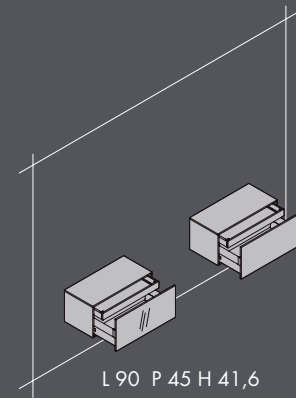

L 90 P 45 H 41,6

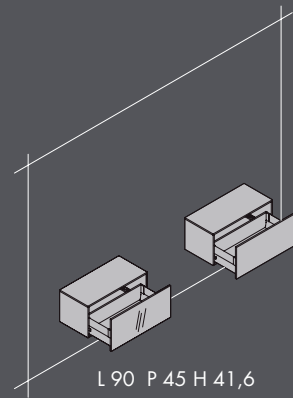

L 90 P 45 H 41,6

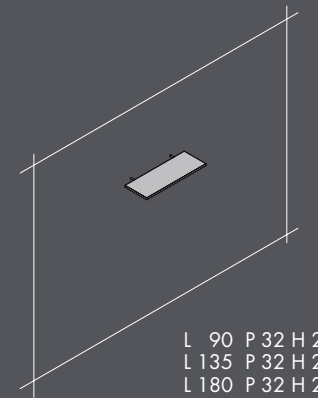

L 90 P 32 H 2,5
L 135 P 32 H 2,5
L 180 P 32 H 2,5

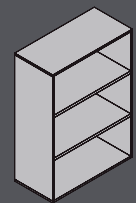

L 90 P 45 H 85
L 90 P 45 H 127
L 90 P 45 H 210

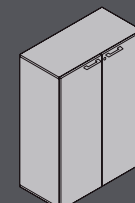

L 90 P 45 H 85
L 90 P 45 H 127
L 90 P 45 H 210

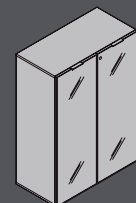

L 90 P 45 H 85
L 90 P 45 H 127
L 90 P 45 H 210

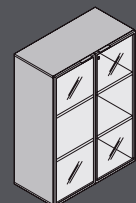

L 90 P 45 H 85
L 90 P 45 H 127
L 90 P 45 H 210

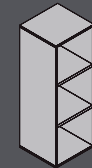

L 45 P 45 H 85
L 45 P 45 H 127
L 45 P 45 H 210

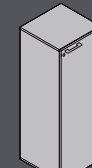

L 45 P 45 H 85
L 45 P 45 H 127
L 45 P 45 H 210

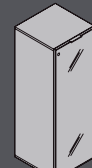

L 45 P 45 H 85
L 45 P 45 H 127
L 45 P 45 H 210

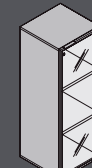

L 45 P 45 H 85
L 45 P 45 H 127
L 45 P 45 H 210

PAGG.	DESCRIZIONE MODELLO:	DESCRIZIONE FINITURE
04-05	Scrivania direzionale L160 P164; piano N2WE - gambe A1CF - giunti A1CF Contenitore portante L164 P60; struttura N3NJ - ante E1NY - telaio 20/45 A1AL - top e fianchi N2WE Mobili contenitori H85: ante N2WE - maniglie D914 - top e fianchi N2WE	
06-07	Scrivania direzionale L200 P90; piano N3NS - gambe A1BD - giunti A1CF Contenitore portante L164 P60; struttura N3BD - ante E1BD - telaio 20/45 A1AL - top e fianchi N3NS Libreria alluminio H210; struttura A2BD - ripiani E1BD	
08-09	Scrivania direzionale L200 P90; piano E1BD - gambe A1BD - giunti A1CF Mobile di servizio L122 P55: ante N3LG - maniglie D904 - top e fianchi N3LG Mobili contenitori H85: ante N3LG - maniglie D914 - top e fianchi N3LG	
10-11	Scrivania direzionale L220 P100; piano E1EC - gambe A1CF - giunti A1CF - travi A1CF Dattilo L120 P60; piano E1EC - gambe A1CF - giunti A1CF - travi A1CF Cassettiera: struttura e cassetti M3CF Tavolo riunioni L240 P124; piano N3RT - gambe A1CF - giunti A1CF Mobili contenitori H210: ante N3RT - maniglia D912 - top e fianchi N3RT	
12-13	Scrivania direzionale L200 P90; piano V1GE - gambe A2NY - giunti A2NY - trave A2NY Contenitore portante L164 P60; struttura L2NY - ante E1GY - telaio 20/45 A1AL - top e fianchi L2NY Libreria alluminio H210; struttura A2NY - ripiani E1NY Mobili contenitori H127: ante E1YG - telaio 20/45 A1AL - top e fianchi L2NY	
14-15	Tavolo riunioni L160 P164; piano E1NY - gambe A1BD - giunti A1BD Libreria melaminico H167; struttura L2BD - ante push&pull E2GY - frameless	
16-17	Scrivania direzionale L200 P90; piano N3BD - gambe A1BD - giunti A1BD Mobile di servizio L122 P55: ante N3BD - struttura N3BD Basi e pensili sospesi L90; struttura N3BD/N3NJ - ante push&pull N3BD/N3NJ	
18-19	Scrivania direzionale L180 P90; piano N3RT - gambe A1NY - giunti A1NY Basi e pensili sospesi L90; struttura N3NJ - ante push&pull E1EC - telaio 20/20 A2NY	
20-21	Scrivania con allungo L180 P210; piano I1NC - gambe A1BD - giunti A1BD Cassettiera: struttura e cassetti I1NC - maniglie D902 Tavolo tondo Ø120; piano E1EC - gambe A2BD - giunti A2BD - trave A2BD Mobili contenitori H210: ante I1NC - maniglie D912 - ante E1BD - telaio 20/45 A2BD - top e fianchi I1NC	
22-23	Scrivania con allungo L200 P210; piano I1NS - gambe RAL1019 - giunti RAL1019 Cassettiera: struttura e cassetti I1NS - maniglie D905 Tavolo riunioni L320 P164; piano I1NS - gambe RAL1019 - giunti RAL1019 Basi e pensili sospesi L90; struttura L2RC - ante push&pull L2RC Libreria alluminio H210; struttura A1AL - ripiani L2RC	
24-25	Scrivania con allungo L200 P210; piano N1NN - gambe A1CF - giunti A1CF Cassettiera: struttura e cassetti N1NN - maniglie D904 Mobili contenitori H85: ante N1NN - maniglie D914 - top e fianchi N1NN	
26-27	Scrivania direzionale L200 P90; piano E1NY - gambe A1NY - giunti A1NY Mobile di servizio L122 P55: ante I1NS - maniglie D904 - top e fianchi E1NY Mobili contenitori H85: ante I1NS - maniglie D914 - top e fianchi I1NS Tavolo riunioni L480 P164; piano I1NS - gambe A1NY - giunti A1NY Mobili contenitori H127: ante E1NY - telaio 20/45 A1AL - top e fianchi I1NS	
28-29	Scrivania direzionale L220 P100; piano L5TS - gambe A1BD - giunti A1BD Contenitore portante L164 P60; struttura N3BD - ante E1BD - telaio 20/45 A1AL - top e fianchi L2TS Mobili contenitori H85: ante N3BD - maniglie D914 - top e fianchi N3RT Tavolo riunioni L160 P164; piano N3RT - gambe A1GY - giunti A1GY Basi e pensili sospesi L90; struttura N3BD - ante push&pull N3BD	
30-31	Scrivania direzionale L180 P80; piano I1NS - gambe A1CF - giunti A1CF Contenitore portante L164 P60; struttura N3BD - ante E1BD - telaio 20/45 A1AL - top e fianchi N3BD Mobili contenitori H127: ante E1BD - telaio 20/45 A1AL - top e fianchi N3BD	
32-33	Scrivania direzionale L160 P164; piano L5GY - gambe A1GY - giunti A1GY Contenitore portante L164 P60; struttura L2GY - ante L2GY - top e fianchi L2GY - maniglia D902 Contenitore portante L84 P60; struttura L2GY - cassetti L2GY - top e fianchi L2GY - maniglia D902 Mobili contenitori H85: ante L2GY - maniglie D915 - top e fianchi L2GY	
34-35	Scrivania direzionale L220 P100; piano N3RF Contenitore portante L164 P60; struttura N3NJ - ante E1BD - telaio 20/45 A1AL - top e fianchi N3RF Contenitore portante L84 P60; struttura N3NJ - cassetti N3RF - top e fianchi N3RF - maniglie D905 Tavolo riunioni L240 P124; piano N3RF - gambe A1BD - giunti A1BD Mobili contenitori H85: ante N3RF - maniglie D915 - top e fianchi N3RF	
36-37	Libreria alluminio H210; struttura A1AL - ripiani E1NY Libreria alluminio H210; struttura A2BD - ripiani L2NY	
38-39	Scrivania direzionale con allungo frontale L220 P220; piano N2WE - gambe A1CF - giunti A1CF Gonna frontale H41; struttura N2WE Cassettiera: struttura e cassetti M3CF Mobili contenitori H210: ante N2WE - maniglie D915 - ante E1NY - telaio 20/45 A1AL - top e fianchi N2WE	
42-43	Tavolo riunioni L480 P164; piano N3LG - gambe A1BD - giunti A1BD Mobili contenitori H210; struttura N3BD - ante N3LG - maniglia D914	
44-45	Tavolo riunioni L160 P164; piano RAL8022 - gambe RAL8022 - giunti A1CF Tavolo tondo Ø120; piano E2BD - gambe A1BD - giunti A1CF Libreria melaminico H167; struttura RAL8022 - ante push&pull E2BD	
46-47	Tavolo riunioni L480 P164; piano N3CB - gambe A1BD - giunti A1BD Mobili contenitori H210; struttura N3BD - ante N3CB - maniglie D915	
48-49	Tavolo riunioni L240 P124; piano E1EC - gambe A2NY - giunti A2NY - trave A2NY Mobili contenitori H85: ante N3NS - maniglie D915 - top e fianchi N3NS	
50-51	Tavolo riunioni L240 P124; piano E1EC - gambe A2NY - giunti A2NY - trave A2NY Mobili contenitori H210; struttura N3NJ - ante N3RT - maniglie D904 Libreria alluminio H210; struttura A2NY - ripiani L2NY	
52-53	Tavolo riunioni L240 P124; piano N3NS - gambe A1CF - giunti A1CF Mobili contenitori H85: ante N3NS - maniglie D915 - top e fianchi N3NS Pensili alluminio: struttura A1AL - ripiani N3BD Consolle L180 P45; piano I1NS - gambe A1CF - giunti A1CF Cassettiera: struttura e cassetti M3CF Pensili alluminio: struttura A2BD - ripiani N3BD	
54-55	Scrivania direzionale L180 P80; piano N1NN - gambe A1CF - giunti A1CF Contenitore portante L164 P60; struttura N3BD - ante N1NN - maniglia D905 - top e fianchi N1NN Gonna frontale H41; struttura N1NN	

MODEL DESCRIPTION: FINISHINGS DESCRIPTION

Executive desk L160 D164: desk top N2WE - legs A1CF - joints A1CF
Supporting container L164 D60: structure N3NJ - door E1NY - frame 20/45 A1AL - top and sides N2WE
Storage units H85: doors N2WE - handles D914 - top and sides N2WE

Executive desk L200 D90: desk top N3NS - legs A1BD - joints A1CF
Supporting container L164 D60: structure N3BD - door E1BD - frame 20/45 A1AL - top and sides N3NS
Aluminium Bookcase H210: structure A2BD - shelves E1BD

Executive desk L200 D90: desk top E1BD - legs A1BD - joints A1CF
Service unit L122 D55: door N3LG - handles D904 - top and sides N3LG
Storage units H85: doors N3LG - handles D914 - top and sides N3LG

Executive desk L220 D100: desk top E1EC - legs A1CF - joints A1CF - beams A1CF
Side desk L120 D60: desk top E1EC - legs A1CF - joints A1CF - beams A1CF
Pedestal: structure and drawer fronts M3CF
Meeting table L240 D124: desk top N3RT - legs A1CF - joints A1CF
Storage units H210: doors N3RT - handles D912 - top and sides N3RT

Executive desk L200 D90: desk top V1GE - legs A2NY - joints A2NY - beams A2NY
Supporting container L164 P60: structure L2NY - door E1GY - frame 20/45 A1AL - top and sides L2NY
Aluminium Bookcase H210: structure A2NY - shelves E1NY
Storage units H127: doors E1YG - frame 20/45 A1AL - top and sides L2NY

Meeting table L160 D164: desk top E1NY - legs A1BD - joints A1BD
MFC Bookcase H167: structure L2BD - frameless door push&pull E2GY

Executive desk L200 D90: desk top N3BD - legs A1BD - joints A1BD
Service unit L122 D55: door N3BD - structure N3BD
Hanging bases and upper cabinets L90: structure N3BD/N3NJ - door push&pull N3BD/N3NJ

Executive desk L180 D90: desk top N3RT - legs A1NY - joints A1NY
Hanging bases and upper cabinets L90: structure N3NJ - door push&pull E1EC - frame 20/20 A2NY

Desk with side extension L180 D210: desk top I1NC - legs A1BD - joints A1BD
Pedestal: structure and drawer fronts I1NC - handles D902
Round table Ø120: desk top E1EC - legs A2BD - joints A2BD - beams A2BD
Storage units H210: doors N1NC - handles D912 - doors E1BD - frame 20/45 A2BD - top and sides I1NC

Desk with side extension L200 D210: desk top I1NS - legs RAL1019 - joints RAL1019
Pedestal: structure and drawer fronts I1NS - handles D905
Meeting table L320 D164: desk top I1NS - legs RAL1019 - joints RAL1019
Hanging bases and upper cabinets L90: structure L2RC - doors push&pull L2RC
Aluminium Bookcase H210: structure A1AL - shelves L2RC

Desk with side extension L200 D210: desk top N1NN - legs A1CF - joints A1CF
Pedestal: structure and drawer fronts N1NN - handles D904
Storage units H85: doors N1NN - handles D914 - top and sides N1NN

Executive desk L200 D90: desk top E1NY - legs A1NY - joints A1NY
Service unit L122 D55: doors I1NS - handles D904 - top and sides E1NY
Storage units H85: doors I1NS - handles D904 - top and sides I1NS
Meeting table L480 D164: desk top I1NS - legs A1NY - joints A1NY
Storage units H127: doors E1NY - frame 20/45 A1AL - top and sides I1NS

Executive desk L220 D100: desk top L5TS - legs A1BD - joints A1BD
Supporting container L164 D60: structure N3BD - door E1BD - frame 20/45 A1AL - top and sides L2TS
Storage units H85: doors N3BD - handles D914 - top and sides N3RT
Meeting table L160 D164: desk top N3RT - legs A1GY - joints A1GY
Hanging bases and upper cabinets L90: structure N3BD - doors push&pull N3BD

Executive desk L180 D80: desk top I1NS - legs A1CF - joints A1CF
Supporting container L164 D60: structure N3BD - door E1BD - frame 20/45 A1AL - top and sides N3BD
Storage units H127: doors E1BD - frame 20/45 A1AL - top and sides N3BD

Executive desk L160 D164: desk top L5GY - legs A1GY - joints A1GY
Supporting container L164 D60: structure L2GY - door L2GY - top and sides L2GY - handles D902
Supporting container L84 D60: structure L2GY - drawer fronts L2GY - top and sides L2GY - handles D902
Storage units H85: doors L2GY - handles D915 - top and sides L2GY

Executive desk L220 D100: desk top N3RF
Supporting container L164 D60: structure N3NJ - door E1BD - frame 20/45 A1AL - top and sides N3RF
Supporting container L84 D60: structure N3NJ - drawer fronts N3RF - top and sides N3RF - handles D905
Meeting table L240 D124: desk top N3RF - legs A1BD - joints A1BD
Storage units H85: doors N3RF - handles D915 - top and sides N3RF

Aluminium Bookcase H210: structure A1AL - shelves E1NY
Aluminium Bookcase H210: structure A2BD - shelves L2NY

Executive desk with front extension L220 D220: desk top N2WE - legs A1CF - joints A1CF
Modesty panel H41: structure N2WE
Pedestal: structure and drawer fronts M3CF
Storage units H210: doors N2WE - handles D915 - doors E1NY - frame 20/45 A1AL - top and sides N2WE

Meeting table L480 D164: desk top N3LG - legs A1BD - joints A1BD
Storage units H210: structure N3BD - doors N3LG - handles D914

Meeting table L160 D164: desk top RAL8022 - legs RAL8022 - joints A1CF
Round meeting table Ø120: desk top E2BD - legs A1BD - joints A1CF
MFC Bookcase H167: structure RAL8022 - doors push&pull E2BD

Meeting table L480 D164: desk top N3CB - legs A1BD - joints A1BD
Storage units H210: structure N3BD - doors N3CB - handles D915

Meeting table L240 D124: desk top E1EC - legs A2NY - joints A2NY - beams A2NY
Storage units H85: doors N3NS - handles D915 - top and sides N3NS

Meeting table L240 D124: desk top E1EC - legs A2NY - joints A2NY - beams A2NY
Storage units H210: structure N3NJ - doors N3RT - handles D904
Aluminium Bookcase H210: structure A2NY - shelves L2NY

Meeting table L240 D124: desk top N3NS - legs A1CF - joints A1CF
Storage units H85: doors N3NS - handles D915 - top and sides N3NS
Aluminium hanging cabinets: structure A1AL - shelves N3BD
Console L180 D45: work top I1NS - legs A1CF - joints A1CF
Pedestal: structure and drawer fronts M3CF
Aluminium hanging cabinets: structure A2BD - shelves N3BD

Executive desk L180 D80: desk top N1NN - legs A1CF - joints A1CF
Supporting container L164 D60: structure N3BD - door N1NN - handle D905 - top and sides N1NN
Modesty panel H41: structure N1NN

DESCRIPTION DE MODÈLE : DESCRIPTION DE FINITIONS

Bureau direction L160 P164: plateau N2WE - piétement A1CF - liaisons A1CF
Élément de rangement latéral, porteur L164 P60: structure N3NJ - porte E1NY - cadre 20/45 A1AL - top et panneaux latéraux N2WE
Armoires H85: portes N2WE - poignées D914 - top et panneaux latéraux N2WE

Bureau direction L200 P90: plateau N3NS - piétement A1BD - liaisons A1CF
Élément de rangement latéral, porteur L164 P60: structure N3BD - porte E1BD - cadre 20/45 A1AL - top et panneaux latéraux N3NS
Bibliothèque en alu H210: structure A2BD - étagères E1BD

Bureau direction L200 P90: plateau E1BD - piétement A1BD - liaisons A1CF
Meuble de rangement L122 P55: portes N3LG - poignées D904 - top et panneaux latéraux N3LG
Armoires H85: portes N3LG - poignées D914 - top et panneaux latéraux N3LG

Bureau direction L220 P100: plateau E1EC - piétement A1CF - liaisons A1CF - poutres A1CF
Table auxiliaire L120 P60: plateau E1EC - piétement A1CF - liaisons A1CF - poutres A1CF
Caisson: structure et tiroirs M3CF
Table réunion L240 P124: plateau N3RT - piétement A1CF - liaisons A1CF
Armoires H210: portes N3RT - poignée D912 - top et panneaux latéraux N3RT

Bureau direction L200 P90: plateau V1GE - piétement A2NY - liaisons A2NY - poutre A2NY
Élément de rangement latéral, porteur L164 P60: structure L2NY - porte E1GY - cadre 20/45 A1AL - top et panneaux latéraux L2NY
Bibliothèque en alu H210: structure A2NY - étagères E1NY
Armoires H127: portes E1YG - cadre 20/45 A1AL - top et panneaux latéraux L2NY

Table réunion L160 P164: plateau E1NY - piétement A1BD - liaisons A1BD
Bibliothèque en mélaminé H167: structure L2BD - porte push&pull E2GY - sans cadre

Bureau direction L200 P90: plateau N3BD - piétement A1BD - liaisons A1BD
Meuble de rangement L122 P55: porte N3BD - structure N3BD
Éléments de rangement suspendus L90: structure N3BD/N3NJ - porte push&pull N3BD/N3NJ

Bureau direction L180 P90: plateau N3RT - piétement A1NY - liaisons A1NY
Éléments de rangement suspendus L90: structure N3NJ - porte push&pull E1EC - cadre 20/20 A2NY

Bureau avec retour L180 P210:plateau I1NC - piétement A1BD - liaisons A1BD
Caisson: structure et tiroirs I1NC - poignées D902
Table ronde Ø120: plateau E1EC - piétement A2BD - liaisons A2BD - poutre A2BD
Armoires H210: portes I1NC - poignées D912 - portes E1BD - cadre 20/45 A2 BD - top et panneaux latéraux I1NC

Bureau avec retour L200 P210:plateau I1NS - piétement RAL1019 - liaisons RAL1019
Caisson: structure et tiroirs I1NS - poignées D905
Table réunion L320 P164: plateau I1NS - piétement RAL1019 - liaisons RAL1019
Éléments de rangement suspendus L90: structure L2RC - portes push&pull L2RC
Bibliothèque en alu H210:structure A1AL - étagères L2RC

Bureau avec retour L200 P210:plateau N1NN - piétement A1CF - liaisons A1CF
Caisson: structure et tiroirs N1NN - poignées D904
Armoires H85: portes N1NN - poignées D914 - top et panneaux latéraux N1NN

Bureau direction L200 P90: plateau E1NY - piétement A1NY - liaisons A1NY
Meuble de rangement L122 P55: porte I1NS - poignées D904 - top et panneaux latéraux E1NY
Armoires H85: portes I1NS - poignées D914 - top et panneaux latéraux I1NS
Table réunion L480 P164: plateau I1NS - piétement A1NY - liaisons A1NY
Armoires H127: portes E1NY - cadre 20/45 A1AL - top et panneaux latéraux I1NS

Bureau direction L220 P100: plateau L5TS - piétement A1BD - liaisons A1BD
Élément de rangement latéral, porteur L164 P60: structure N3BD - porte E1BD - cadre 20/45 A1AL - top et panneaux latéraux L2TS
Armoires H85: portes N3BD - poignées D914 - top et panneaux latéraux N3RT
Table réunion L160 P164: plateau N3RT - piétement A1GY - liaisons A1GY
Éléments de rangement suspendus L90: structure N3BD - porte push&pull N3BD

Bureau direction L180 P80: plateau I1NS - piétement A1CF - liaisons A1CF
Élément de rangement latéral, porteur L164 P60: structure N3BD - porte E1BD - cadre 20/45 A1AL - top et panneaux latéraux N3BD
Armoires H127: porte E1BD - cadre 20/45 A1AL - top et panneaux latéraux N3BD

Bureau direction L160 P164: plateau L5GY - piétement A1GY - liaisons A1GY
Élément de rangement latéral, porteur L164 P60: structure L2GY - porte L2GY - top et panneaux latéraux L2GY - poignée D902
Élément de rangement latéral, porteur L84 P60: structure L2GY - tiroirs L2GY - top et panneaux latéraux L2GY - poignée D902
Armoires H85: portes L2GY - poignées D915 - top et panneaux latéraux L2GY

Bureau direction L220 P100: plateau N3RF
Élément de rangement latéral, porteur L164 P60: structure N3NJ - porte E1BD - cadre 20/45 A1AL - top et panneaux latéraux N3RF
Élément de rangement latéral, porteur L84 P60: structure N3NJ - tiroirs N3RF - top et panneaux latéraux N3RF - poignées D905
Table réunion L240 P124: plateau N3RF - piétement A1BD - liaisons A1BD
Armoires H85: portes N3RF - poignées D915 - top et panneaux latéraux N3RF

Bibliothèque en alu H210: structure A1AL - étagères E1NY
Bibliothèque en alu H210: structure A2BD - étagères L2NY

Bureau direction avec extension frontale L220 P220: plateau N2WE - piétement A1CF - liaisons A1CF
Voile de fond H41: structure N2WE
Caisson: structure et tiroirs M3CF
Armoires H210: portes N2WE - poignées D915 - portes E1NY - cadre 20/45 A1AL - top et panneaux latéraux N2WE

Table réunion L480 P164: plateau N3LG - piétement A1BD - liaisons A1BD
Armoires H210: structure N3BD - portes N3LG - poignée D914

Table réunion L160 P164: plateau RAL8022 - piétement RAL8022 - liaisons A1CF
Table ronde Ø120: plateau E2BD - piétement A1BD - liaisons A1CF
Bibliothèque en mélaminé H167: structure RAL8022 - porte push&pull E2BD

Table réunion L480 P164: plateau N3CB - piétement A1BD - liaisons A1BD
Armoires H210: structure N3BD - portes N3CB - poignées D915

Table réunion L240 P124: plateau E1EC - piétement A2NY - liaisons A2NY - poutre A2NY
Armoires H85: portes N3NS - poignées D915 - top et panneaux latéraux N3NS

Table réunion L240 P124: plateau E1EC - piétement A2NY - liaisons A2NY - poutre A2NY
Armoires H210: structure N3NJ - portes N3RT - poignées D904
Bibliothèque en alu H210: structure A2NY - étagères L2NY

Table réunion L240 P124: plateau N3NS - piétement A1CF - liaisons A1CF
Armoires H85: portes N3NS - poignées D915 - top et panneaux latéraux N3NS
Éléments de rangement en alu, suspendus: structure A1AL - étagères N3BD
Table auxiliaire L180 P45: plateau I1NS - piétement A1CF - liaisons A1CF
Caisson: structure et tiroirs M3CF
Éléments de rangement en alu, suspendus: structure A2BD - étagères N3BD

Bureau direction L180 P80: plateau N1NN - piétement A1CF - liaisons A1CF
Élément de rangement latéral, porteur L164 P60: structure N3BD - porte N1NN - poignée D905 - top et panneaux latéraux N1NN
Voile de fond H41: structure N1NN

Mobilpref S.p.A. si riserva il diritto di apportare ai propri prodotti le modifiche ritenute utili o necessarie, senza pregiudicare le caratteristiche essenziali dei prodotti stessi.

Mobilpref S.p.A. reserves itself the right to effectuate any modifications deemed useful or necessary to its products, provided such modifications do not interfere with the essential characteristics of said products.

Mobilpref S.p.A. se réserve le droit d’apporter les modifications jugées utiles ou nécessaires à ses propres produits, sans compromettre les caractéristiques essentielles des produits eux-mêmes.



Design: solodesign
A.D. e progetto grafico:
pubblicom@eurosito.com
Immagine: Virtual Design - TN
Stampa: Grafiche Ricciarelli
Edizione 01: 09.2012



About Office by Moblipref S.p.A.
Via Carlo Maccari, 1
Zona Industriale Baraccola Sud
60131 Ancona (AN) Italy
t. +39 071.2906920 / f. +39 071.2866429
info@about-office.com / www. about-office.com